

WORLD MARKET®

Assembly Instructions

ORB GLASS 3-LT MTL FLR LAMP







SKU 636872

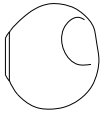

THANK YOU FOR YOUR PURCHASE. IF YOU HAVE ANY QUESTIONS
PERTAINING TO THE ASSEMBLY OF THIS LIGHTING PIECE, PLEASE CONTACT
THE NEAREST WORLD MARKET STORE.
IF YOU ARE NOT NEAR A STORE, PLEASE CALL OUR CUSTOMER SERVICE CALL
CENTER TOLL FREE AT 877-967-5362 FOR ASSISTANCE.

ALL PRODUCTS SOLD AT WORLD MAKEKT ARE NOT FOR COMMERCIAL USE
AND ARE INTENDED FOR RESIDENTIAL USE ONLY.

Component List

LABEL	PICTURE	DESCRIPTION	QTY
A		Glass Shade	3
B		Lamp Body	1
C		Base	1
D		Screw	1
E		Wrench	1
F		G9 LED Bulb	3

Assembly Steps

Step 1

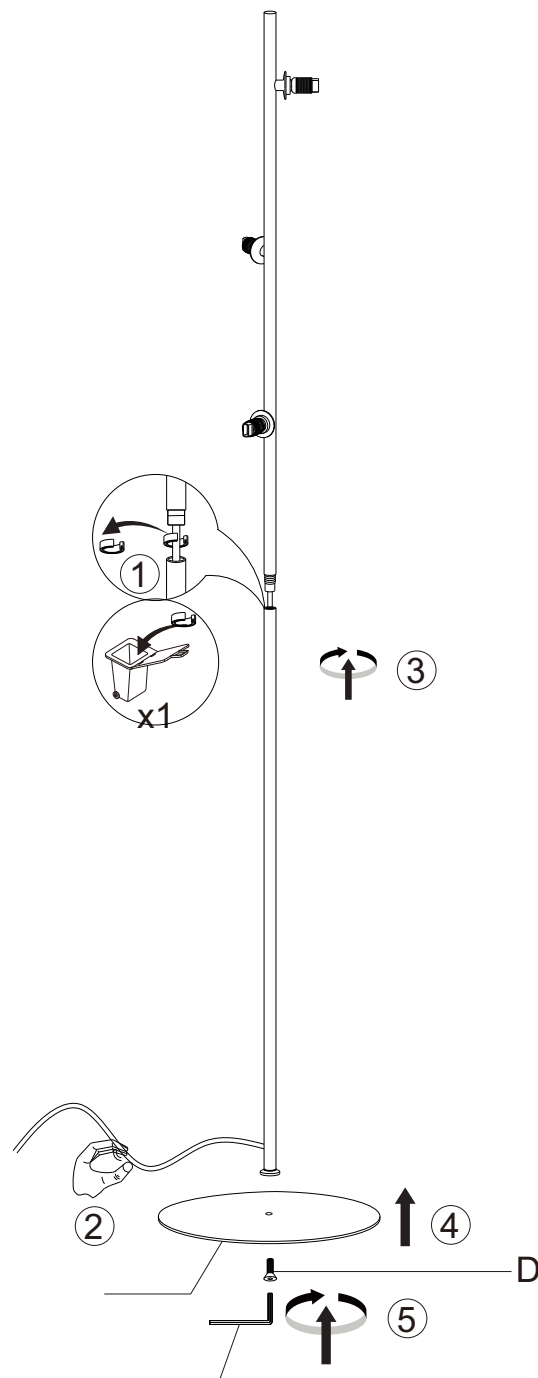

1. Remove the sleeves.
2. Release the twisting cord.
3. Turn the lower tube into the upper tube .
4. Use screw(D) turn through base(C) into the end screw of lamp body.
5. Tighten by wrench(E).

Step 2

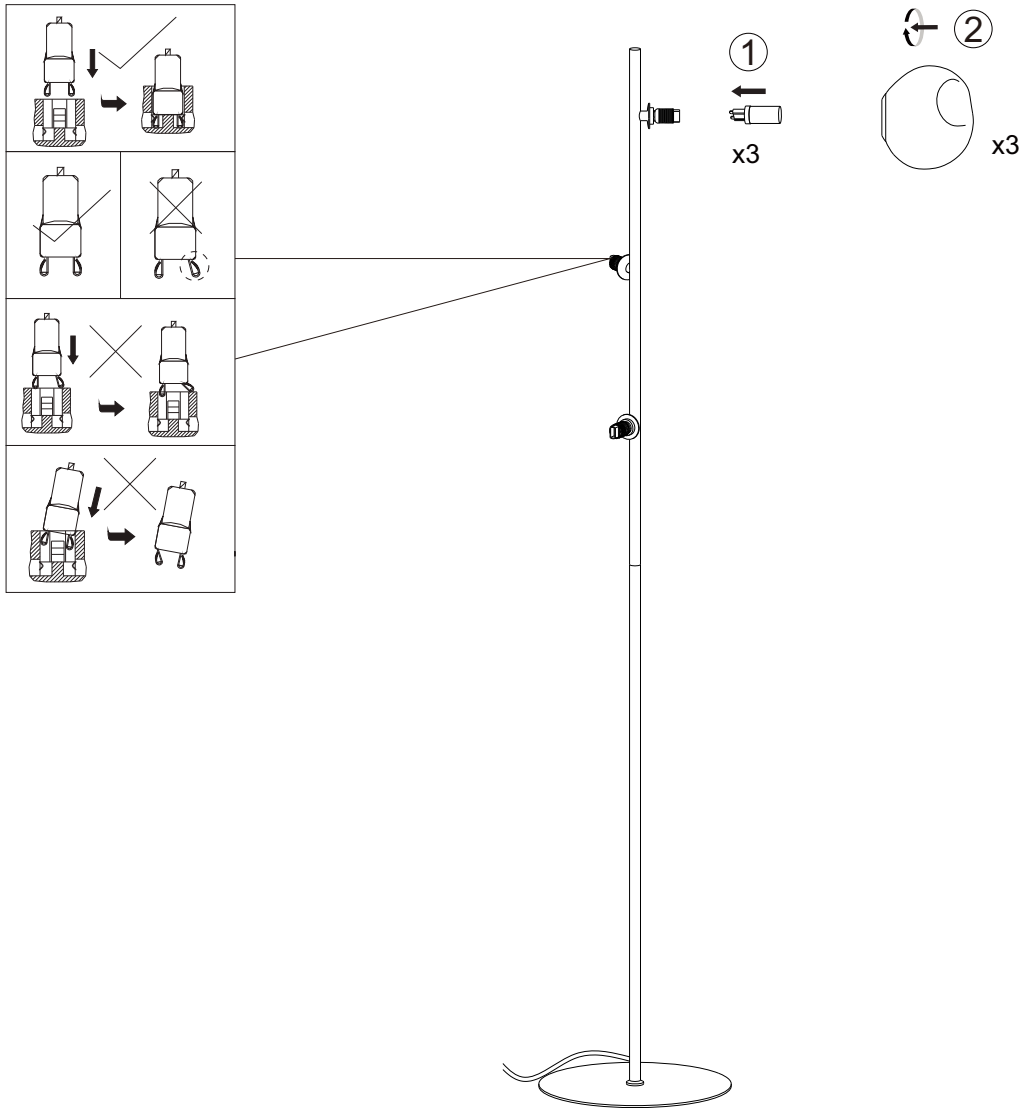

To help prevent the risk of fire, do not use light bulbs with more than Type G9 3W LED (included).

1. Insert the G9 LED bulb(F) into the lampholder.
2. Screw the Glass Shade (A) onto the socket and tighten to secure the Glass Shade(A).

WARNING: DO NOT PLUG IN UNTIL LIGHT BULB IS INSTALLED AND ASSEMBLY IS COMPLETE.

Care & Maintenance

- Do not clean fixture with harsh cleansers or polish as it may damage finish.
- Do not place fixture outside. For indoor use only.
- Not for commercial use. For residential use only.
- Dust and pick up spills using a clean, non-colored, lint-free and soft cloth.